

Cable plug in molded plastic - K-8E-OE/2,0-H00/M23FK-C5-S - 1622230

Please be informed that the data shown in this PDF Document is generated from our Online Catalog. Please find the complete data in the user's documentation. Our General Terms of Use for Downloads are valid (<http://phoenixcontact.com/download>)



Cable plug in molded plastic, Length: 2 m, Color of outer sheath: orange RAL 2003

Why buy this product

- ✓ Transmission of signals, data, and power in just a single connector
- ✓ CAT5 data interface
- ✓ Customer-specific assemblies and cable lengths can be supplied
- ✓ Simple and safe: 100% electrically tested and assembled ready for use
- ✓ Designs with pre-assembled cables on one or both sides
- ✓ Easy connection: angled design with configurable cable outlet direction

Key Commercial Data

Packing unit	1 STK
Minimum order quantity	2 STK
Custom tariff number	85444290
Country of origin	Germany

Technical data

Environmental Product Compliance

REACH SVHC	DOTe 15571-58-1
------------	-----------------

Conductor length	2 m
Nominal current	26 A

Connector specifications

Type	Angled, can be turned, plastic-coated
Housing material	PUR
Thread type	M23
Locking type	SPEEDCON locking
Degree of protection	IP67, when in locked state
	IP68, when in locked state

Cable plug in molded plastic - K-8E-OE/2,0-H00/M23FK-C5-S - 1622230

Technical data

Connector specifications

Number of positions	4+4+4+PE
Direction of rotation	Standard
Type of contact	Socket
Insertion/withdrawal cycles	100
Max. current	30 A
Voltage	630 V AC
Overvoltage category	III
Degree of pollution	3
Rated surge voltage	6 kV

Cable specifications

Type of cable	HDLSL11Y
Signal type	CAT5
Transmission speed	100 Mbps (Data interface)
Shielded	yes
Cable structure	(5x 2.5 + 4x 0.34/C + 4x 0.5) C
Cable structure (AWG)	(14 AWG/ 5 + 22 AWG/ 4c + 20 AWG) C
External cable diameter	14.6 mm ±0.4 mm
Outer sheath, material	PUR
Material wire insulation	TPM (TPM/TPM/polyolefin)
External sheath, color	orange RAL 2003
Single wire, color	Black 1, black 2, black 3, black 4, green/yellow (Power wires: black U/ L1, black V/ L2, black W/ L3, black N/ 4, green/yellow)
	brown, violet, black, green (Signal wires)
	blue, yellow, white, orange (Data wires)
Nominal voltage, cable	1000 V (300 V signal)
Test voltage	4 kV (1.5 kV signal)
Rated current	26 A (Power, according to DIN VDE 0298-4 tab. 11/5)
	8 A (Signal, according to DIN VDE 0298-4 tab. 11/5)
	3.6 A (Data, according to DIN VDE 0298-4 tab. 11/5)
Smallest bending radius, fixed installation	73 mm
Smallest bending radius, movable installation	148 mm
Number of bending cycles	1000000
Traversing path	6 m
Acceleration	2.5 m/s ²
Ambient temperature for fixed installation	-40 °C ... 80 °C
Ambient temperature for flexible installation	-30 °C ... 60 °C
Special properties	Flexible cable conduit capable

Cable plug in molded plastic - K-8E-OE/2,0-H00/M23FK-C5-S - 1622230

Technical data

Cable specifications

Flame resistance	IEC 60332-1-2
Halogen-free	According to EN 50267-2-1
Resistance to oil	EN 60811-2-1

Drawings

Schematic diagram

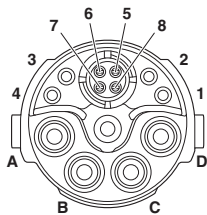

Connector pin assignment

Schematic diagram

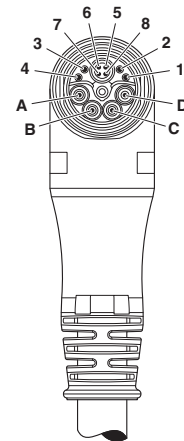

Cable outlet direction

Cable cross section



Dimensional drawing

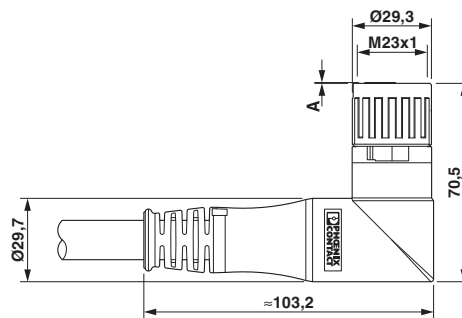

Pin version: dimension A = ~ 0.3 mm, socket version: dimension A = 0 mm

Cable plug in molded plastic - K-8E-OE/2,0-H00/M23FK-C5-S - 1622230

Circuit diagram

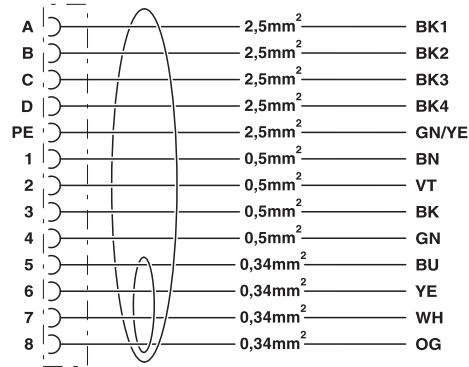

Contact assignment of M23 plugs/sockets

Classifications

eCl@ss

eCl@ss 5.1	27060390
eCl@ss 8.0	27279218
eCl@ss 9.0	27060311

ETIM

ETIM 4.0	EC001855
ETIM 5.0	EC001855

Approvals

Approvals

Approvals

UL Listed / cUL Listed / EAC / cULus Listed

Ex Approvals

Approval details

Cable plug in molded plastic - K-8E-OE/2,0-H00/M23FK-C5-S - 1622230

Approvals

UL Listed  http://database.ul.com/cgi-bin/XYV/template/LISEXT/1FRAME/index.htm E468743-20150929	
Nominal current IN	16 A
Nominal voltage UN	600 V

cUL Listed  http://database.ul.com/cgi-bin/XYV/template/LISEXT/1FRAME/index.htm E468743-20150929	
Nominal current IN	16 A
Nominal voltage UN	600 V

EAC B.00767

cULus Listed 
--

Accessories

Accessories

Conductor marking

Insert label - PABA WH/23 - 1013779



Insert label, Strip, white, unlabeled, can be labeled with: Plotter, Mounting type: Thread on, Cable diameter: 1.5-35 mm, Lettering field: 23 x 4 mm

Insert label - PABA YE/23 - 1013782



Insert label, Strip, yellow, unlabeled, can be labeled with: Plotter, Mounting type: Thread on, Cable diameter: 1.5-35 mm, Lettering field: 23 x 4 mm

Cable plug in molded plastic - K-8E-OE/2,0-H00/M23FK-C5-S - 1622230

Accessories

Marker carrier cable

Conductor marker carrier - PATG 6/23 - 0808037



Conductor marker carrier, transparent, unlabeled, Mounting type: slide on, Cable diameter: 14-22 mm, Lettering field: 4 x 23 mm