

MAX98309/MAX98310

Mono 1.4W Class AB Audio Amplifiers

General Description

The MAX98309/MAX98310 mono 1.4W class AB audio amplifiers offer low quiescent current while maintaining excellent SNR and low 0.008% THD+N. These ICs feature excellent 90dB PSRR and state of the art click-and-pop suppression.

The ICs are offered with an internally fixed 0dB, 3dB, 6dB, and 9dB gain (MAX98310) or an externally set gain (MAX98309) through external resistors.

The MAX98309 feature a 10ms or 100ms pin-selectable turn-on time, while the MAX98310 has a preset 5ms turn-on time.

The MAX98309/MAX98310 are available in a (1.0mm x 1.0mm) 9-bump, 0.3mm pitch WLP, and are specified over the extended -40°C to +85°C temperature range.

Applications

Cell Phones/Smartphones
Digital Cameras
GPS
Portable Media Players
e-Readers
Tablets

Benefits and Features

- ◆ **Enhances System Performance**
 - ◇ Differential Input Improves Noise Immunity
 - ◇ Industry-Leading Click-and-Pop Suppression
 - ◇ High 90dB PSRR ($f_{1N} = 217\text{Hz}$)
- ◆ **Smaller Solution Size**
 - ◇ 1mm x 1mm WLP Footprint
- ◆ **Extends Battery Life**
 - ◇ Low Quiescent Current
- ◆ **Delivers Robust System Design**
 - ◇ Thermal Overload Protection
 - ◇ Short-Circuit Protection
- ◆ **1.2mA Supply Current ($V_{DD} = 3.7\text{V}$)**
- ◆ **750mW into 8Ω ($V_{DD} = 3.7\text{V}$)**
- ◆ **2.5V to 5.5V Supply Operation**
- ◆ **Pin-Selectable, Internally-Fixed Gain (MAX98310)**
- ◆ **1.8V Logic-Compatible SHDN Input**

Ordering Information appears at end of data sheet.

For related parts and recommended products to use with this part, refer to www.maxim-ic.com/MAX98309.related.

Simplified Block Diagram

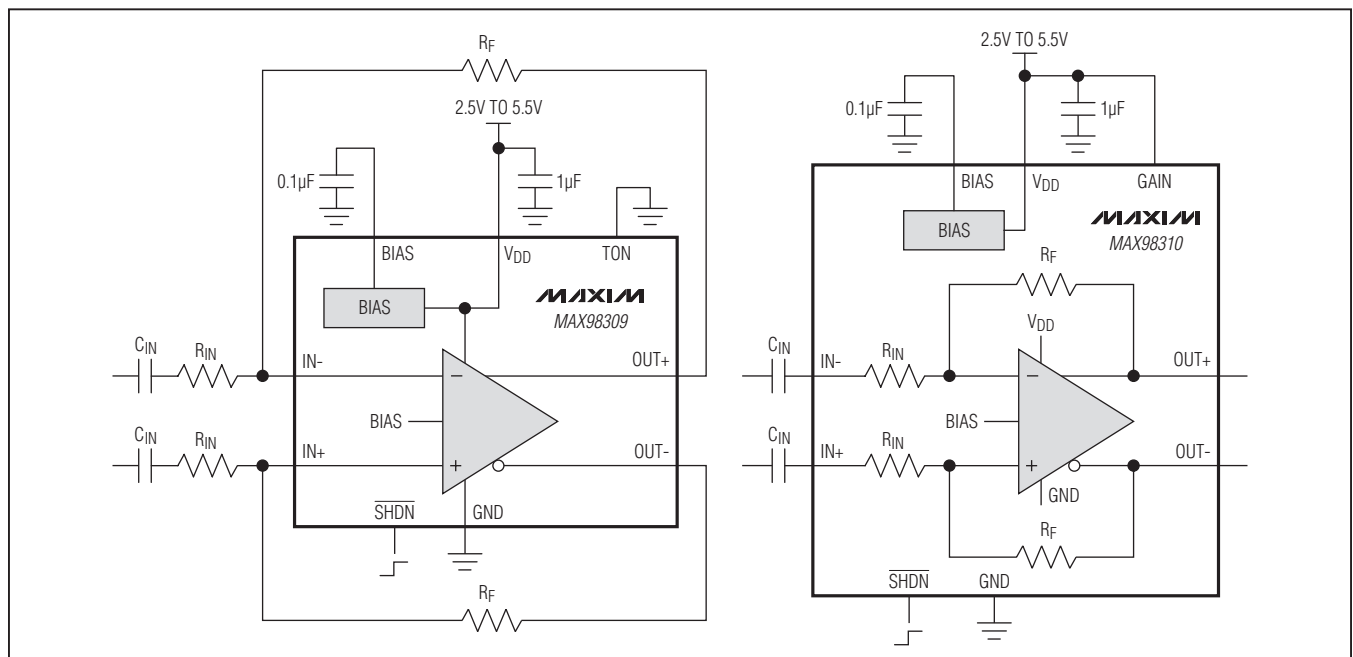

MAX98309/MAX98310

Mono 1.4W Class AB Audio Amplifiers

ABSOLUTE MAXIMUM RATINGS

| | | | |
|--|-------------------------------------|---|---|
| V_{DD} to GND..... | -0.3V to 6V | OUT+ to OUT- Short Circuit Duration | Continuous |
| SHDN to GND | -0.3V to 6V | Continuous Power Dissipation ($T_A = +70^\circ\text{C}$) | |
| All Other Pins to GND | -0.3V to ($V_{DD} + 0.3\text{V}$) | WLP (derate 11.9mW/ $^\circ\text{C}$ above $+70^\circ\text{C}$)..... | 848mW |
| Continuous Current | | Junction Temperature | +150 $^\circ\text{C}$ |
| V_{DD} , GND, OUT_..... | $\pm 750\text{mA}$ | Operating Temperature Range | -40 $^\circ\text{C}$ to +85 $^\circ\text{C}$ |
| IN_, SHDN, BIAS, GAIN, TON..... | $\pm 20\text{mA}$ | Storage Temperature Range..... | -65 $^\circ\text{C}$ to +150 $^\circ\text{C}$ |
| OUT_ Short Circuit to GND or V_{DD} Duration | Continuous | Soldering Temperature (reflow)..... | +260 $^\circ\text{C}$ |

Stresses beyond those listed under "Absolute Maximum Ratings" may cause permanent damage to the device. These are stress ratings only, and functional operation of the device at these or any other conditions beyond those indicated in the operational sections of the specifications is not implied. Exposure to absolute maximum rating conditions for extended periods may affect device reliability.

PACKAGE THERMAL CHARACTERISTICS (Note 1)

WLP

| | |
|---|------------------------------|
| Junction-to-Ambient Thermal Resistance (θ_{JA})..... | 94 $^\circ\text{C}/\text{W}$ |
| Junction-to-Case Thermal Resistance (θ_{JC})..... | 41 $^\circ\text{C}/\text{W}$ |

Note 1: Package thermal resistances were obtained using the method described in JEDEC specification JESD51-7, using a four-layer board. For detailed information on package thermal considerations, refer to www.maxim-ic.com/thermal-tutorial.

ELECTRICAL CHARACTERISTICS

($V_{DD} = 3.7\text{V}$, $V_{GND} = 0\text{V}$, $\overline{\text{SHDN}} = V_{DD}$, GAIN = V_{DD} (0dB), $C_{BIAS} = 0.1\mu\text{F}$, $C_{IN} = 0.47\mu\text{F}$, no load: $R_{IN} = R_F = 10\text{k}\Omega$ (MAX98309), $T_A = T_{MIN}$ to T_{MAX} . Typical values are at $T_A = +25^\circ\text{C}$, unless otherwise noted.) (Note 2)

| PARAMETER | SYMBOL | CONDITIONS | MIN | TYP | MAX | UNITS | |
|--------------------------|---------------|--|------------------------|-----------------|-----------------|---------------|----|
| Supply Voltage Range | V_{DD} | Guaranteed by PSRR test | 2.5 | | 5.5 | V | |
| Undervoltage Lockout | UVLO | V_{DD} falling | | 1.8 | 2.3 | V | |
| Quiescent Supply Current | I_{VDD} | $\overline{\text{SHDN}} = V_{DD}$ | $V_{DD} = 3.7\text{V}$ | 1.2 | | mA | |
| | | | $V_{DD} = 5\text{V}$ | 1.9 | 1.8 | | |
| Shutdown Supply Current | I_{VDD_SD} | $\overline{\text{SHDN}} = 0\text{V}$, $T_A = +25^\circ\text{C}$ | | 2 | 3 | μA | |
| Turn-On Time | t_{ON} | MAX98309 shutdown to full operation | TON = GND | 10 | 22.8 | ms | |
| | | | TON = V_{DD} | 100 | | | |
| | | MAX98310 shutdown to full operation | | 5.7 | 11.5 | | |
| Gain | A_V | MAX98310 | GAIN = V_{DD} | -0.25 | 0 | +0.25 | dB |
| | | | GAIN = GND | 2.75 | 3 | 3.25 | |
| | | | GAIN = unconnected | 5.75 | 6 | 6.25 | |
| | | | GAIN = BIAS | 8.75 | 9 | 9.25 | |
| Gain Selection Threshold | | MAX98310 | GAIN = V_{DD} | 0.80 x V_{DD} | | V | |
| | | | GAIN = GND | 0.05 x V_{DD} | | | |
| | | | GAIN = unconnected | 0.16 x V_{DD} | 0.24 x V_{DD} | | |
| | | | GAIN = BIAS | 0.35 x V_{DD} | 0.69 x V_{DD} | | |

MAX98309/MAX98310

Mono 1.4W Class AB Audio Amplifiers

ELECTRICAL CHARACTERISTICS (continued)

($V_{DD} = 3.7V$, $V_{GND} = 0V$, $\overline{SHDN} = V_{DD}$, $GAIN = V_{DD}$ (0dB), $C_{BIAS} = 0.1\mu F$, $C_{IN} = 0.47\mu F$, no load: $R_{IN} = R_F = 10k\Omega$ (MAX98309), $T_A = T_{MIN}$ to T_{MAX} . Typical values are at $T_A = +25^\circ C$, unless otherwise noted.) (Note 2)

| PARAMETER | SYMBOL | CONDITIONS | | MIN | TYP | MAX | UNITS |
|---------------------------------|--------------------|---|---|-----------------------|---------------------|-----------------------|---------|
| Differential Input Resistance | R_{INDIFF} | MAX98309, $\overline{SHDN} = V_{DD}$ | | 1000 | | k Ω | |
| | | MAX98310 | GAIN = 0dB | 38.2 | | | |
| | | | GAIN = 3dB | 31.7 | | | |
| | | | GAIN = 6dB | 25.5 | | | |
| Input Bias Current | I_{INBIAS} | MAX98309/MAX98310, $\overline{SHDN} = V_{DD}$ | | | ± 1 | μA | |
| Shutdown Input Bias Current | I_{INBIAS_SHDN} | $\overline{SHDN} = GND$, $IN_- = V_{DD}$ or $IN_- = GND$ | | -5 | | +5 | μA |
| Output Offset Voltage | V_{OS} | $T_A = +25^\circ C$ (Note 3) | | | ± 0.2 | ± 1 | mV |
| Click-and-Pop Level | K_{CP} | $R_L = 8\Omega$, 32 samples per second, A-weighted, $T_A = +25^\circ C$ (Notes 3, 4) | Into shutdown | -66 | | dBV | |
| | | | Out of shutdown | -66 | | | |
| Common-Mode Bias Voltage | V_{BIAS} | Voltage at BIAS | | $0.475 \times V_{DD}$ | $0.5 \times V_{DD}$ | $0.525 \times V_{DD}$ | V |
| Input Common-Mode Voltage Range | V_{CM} | Inferred from CMRR test | | 0.5 | | $V_{DD} - 0.6$ | V |
| Common-Mode Rejection Ratio | CMRR | MAX98310/MAX98310 | Guaranteed over input common-mode voltage range | -50 | -76 | dB | |
| | | | $f_{IN} = 1kHz$, $R_L = 8\Omega + 33\mu H$ | -62 | | | |
| Power-Supply Rejection Ratio | PSRR | $V_{RIPPLE} = 200mV_{P-P}$ (Note 3) | DC 2.5V to 5.5V | 73 | 93 | dB | |
| | | | $f_{IN} = 217Hz$ | 90 | | | |
| | | | $f_{IN} = 1kHz$ | 90 | | | |
| | | | $f_{IN} = 10kHz$ | 72 | | | |
| Output Power | P_{OUT} | $V_{DD} = 3.7V$, 1% THD+N | $R_L = 8\Omega + 68\mu H$ | 0.750 | | W | |
| | | | $R_L = 4\Omega + 33\mu H$ | 1.2 | | | |
| | | $V_{DD} = 3.7V$, 10% THD+N | $R_L = 8\Omega + 68\mu H$ | 0.9 | | | |
| | | | $R_L = 4\Omega + 33\mu H$ | 1.5 | | | |
| | | $V_{DD} = 5V$, 1% THD+N (Note 5) | $R_L = 8\Omega + 68\mu H$ | 1.4 | | | |
| | | | $R_L = 4\Omega + 33\mu H$, thermally limited | 2.1 | | | |
| | | $V_{DD} = 5V$, 10% THD+N (Note 5) | $R_L = 8\Omega + 68\mu H$ | 1.7 | | | |
| | | | $R_L = 4\Omega + 33\mu H$, thermally limited | 2.7 | | | |

MAX98309/MAX98310

Mono 1.4W Class AB Audio Amplifiers

ELECTRICAL CHARACTERISTICS (continued)

($V_{DD} = 3.7V$, $V_{GND} = 0V$, $\overline{SHDN} = V_{DD}$, $GAIN = V_{DD}$ (0dB), $C_{BIAS} = 0.1\mu F$, $C_{IN} = 0.47\mu F$, no load: $R_{IN} = R_F = 10k\Omega$ (MAX98309), $T_A = T_{MIN}$ to T_{MAX} . Typical values are at $T_A = +25^\circ C$, unless otherwise noted.) (Note 2)

| PARAMETER | SYMBOL | CONDITIONS | MIN | TYP | MAX | UNITS |
|---|----------|--|------|-------|-----|------------|
| Total Harmonic Distortion Plus Noise | THD+N | $f_{IN} = 1kHz$, BW = 22Hz to 22kHz $R_L = 8\Omega + 68\mu H$, $P_{OUT} = 375mW$ | | 0.008 | | % |
| | | $R_L = 4\Omega + 33\mu H$, $P_{OUT} = 750mW$ | 0.06 | 0.02 | | |
| | | $f_{IN} = 6kHz$, BW = 22Hz to 22kHz $R_L = 8\Omega + 68\mu H$, $P_{OUT} = 375mW$ | | 0.01 | | |
| Signal-to-Noise Ratio | SNR | A-weighted, $V_{DD} = 5V$, $P_{OUT} = 1.4W$, $R_L = 8\Omega + 33\mu H$ | | 110 | | dB |
| Output Noise Voltage | V_N | A-weighted (Note 3) | | 9 | | μV |
| Overcurrent Protection Threshold | | | | 2 | | A |
| Thermal-Protection Threshold | | | | +160 | | $^\circ C$ |
| Thermal-Protection Hysteresis | | | | 15 | | $^\circ C$ |
| Maximum Capacitive Load Drive | C_L | Bridge-tied load capacitance | | 500 | | pF |
| LOGIC INPUT (\overline{SHDN}, TON) (MAX98309) | | | | | | |
| Input Logic-High | V_{IH} | 1.8V logic compliant | 1.4 | | | V |
| Input Logic-Low | V_{IL} | 1.8V logic compliant | | | 0.4 | V |
| Input Leakage Current High | I_{IH} | $T_A = +25^\circ C$ | | | 1 | μA |
| Input Leakage Current Low | I_{IL} | $T_A = +25^\circ C$ | | | 1 | μA |

Note 2: All specifications are 100% tested at $T_A = +25^\circ C$; temperature limits are guaranteed by design.

Note 3: Inputs AC-coupled to GND.

Note 4: Mode transitions controlled by \overline{SHDN} .

Note 5: Thermally limited by package.

Mono 1.4W Class AB Audio Amplifiers

Typical Operating Characteristics

($V_{DD} = 3.7V$, $V_{GND} = 0V$, $\overline{SHDN} = V_{DD}$, GAIN = GND ($R_F = R_{IN} = 10k\Omega$), $C_{BIAS} = 0.1\mu F$, $C_{IN} = 1\mu F$, no load, unless otherwise noted.)

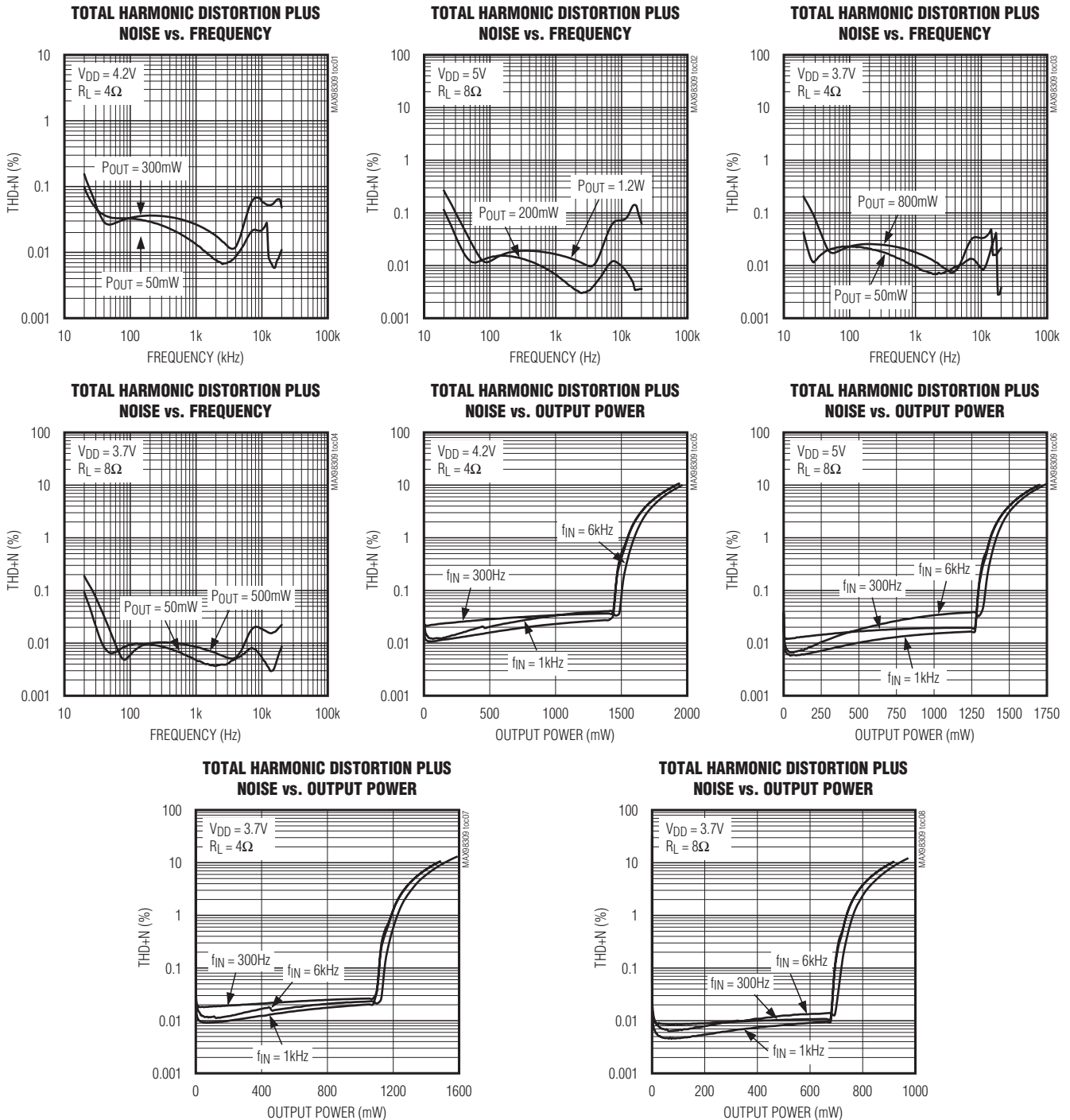

MAX98309/MAX98310

Mono 1.4W Class AB Audio Amplifiers

Typical Operating Characteristics (continued)

($V_{DD} = 3.7V$, $V_{GND} = 0V$, $\overline{SHDN} = V_{DD}$, GAIN = GND ($R_F = R_{IN} = 10k\Omega$), $C_{BIAS} = 0.1\mu F$, $C_{IN} = 1\mu F$, no load, unless otherwise noted.)

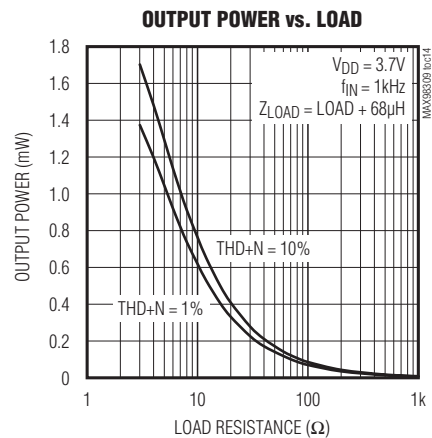
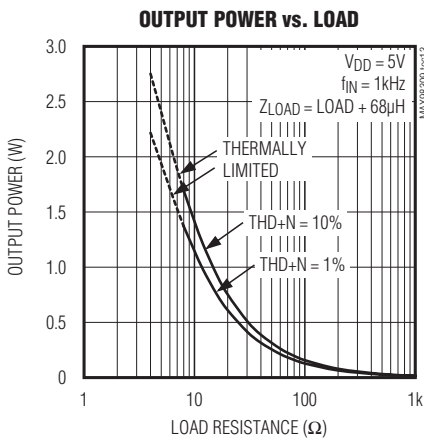
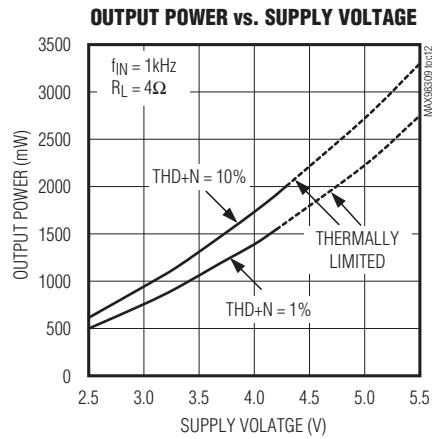
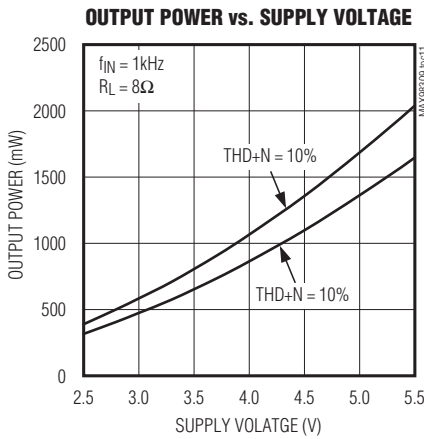
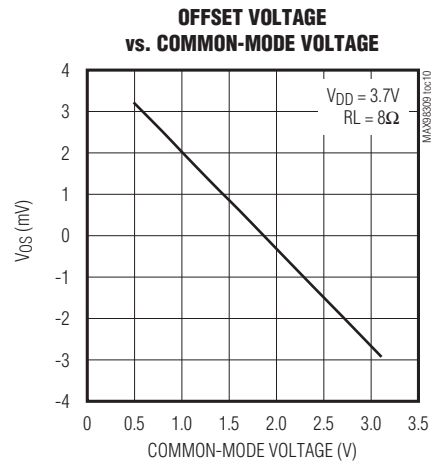
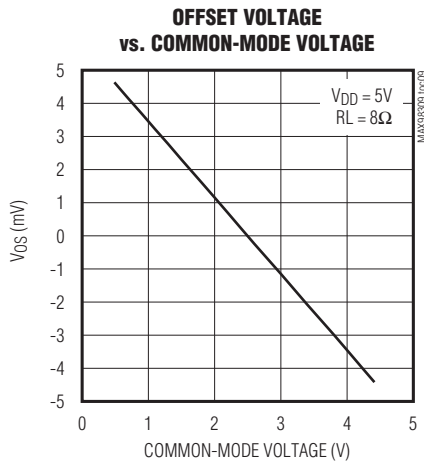

Mono 1.4W Class AB Audio Amplifiers

Typical Operating Characteristics (continued)

($V_{DD} = 3.7V$, $V_{GND} = 0V$, $\overline{SHDN} = V_{DD}$, GAIN = GND ($R_F = R_{IN} = 10k\Omega$), $C_{BIAS} = 0.1\mu F$, $C_{IN} = 1\mu F$, no load, unless otherwise noted.)

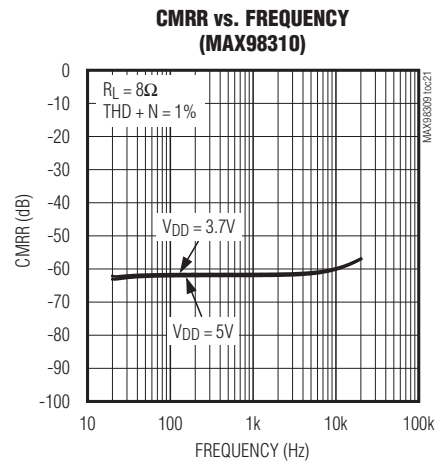
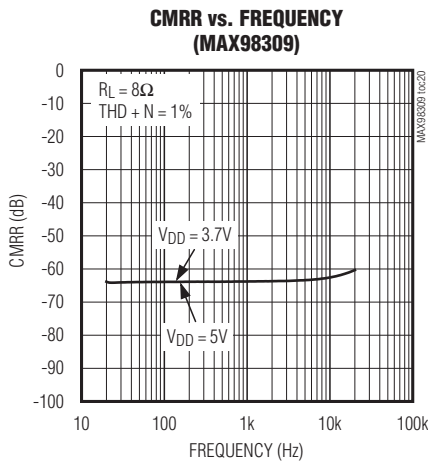
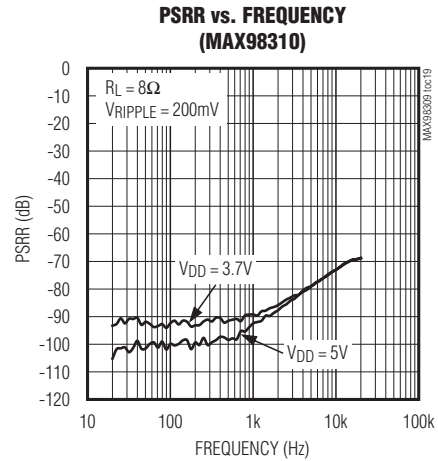
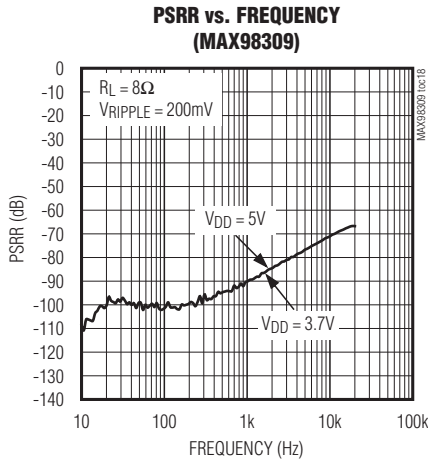
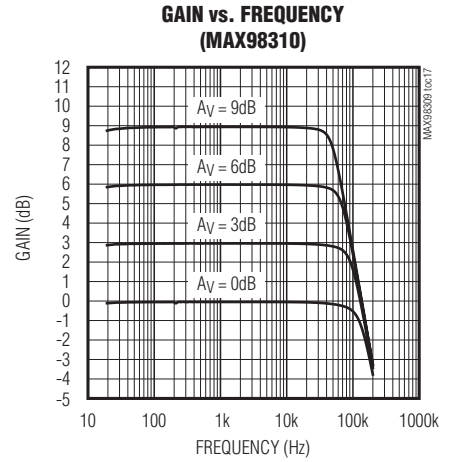
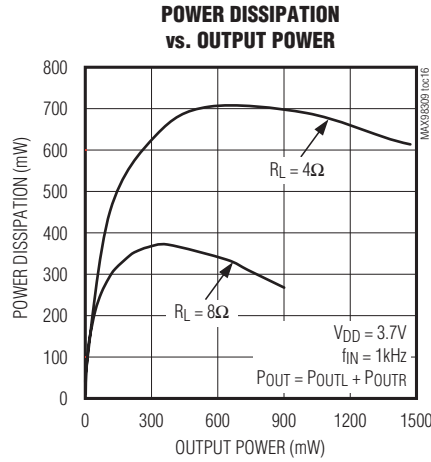
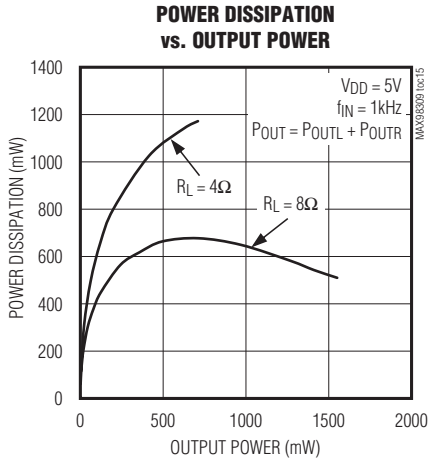

MAX98309/MAX98310

Mono 1.4W Class AB Audio Amplifiers

Typical Operating Characteristics (continued)

($V_{DD} = 3.7V$, $V_{GND} = 0V$, $\overline{SHDN} = V_{DD}$, GAIN = GND ($R_F = R_{IN} = 10k\Omega$), $C_{BIAS} = 0.1\mu F$, $C_{IN} = 1\mu F$, no load, unless otherwise noted.)

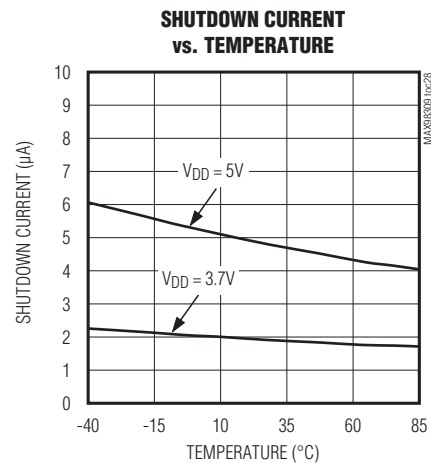
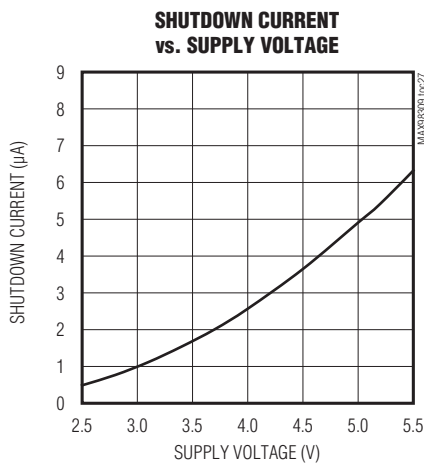
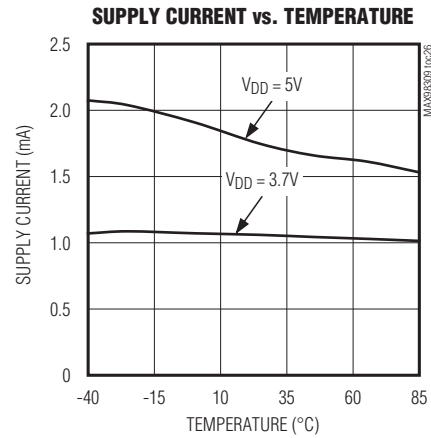
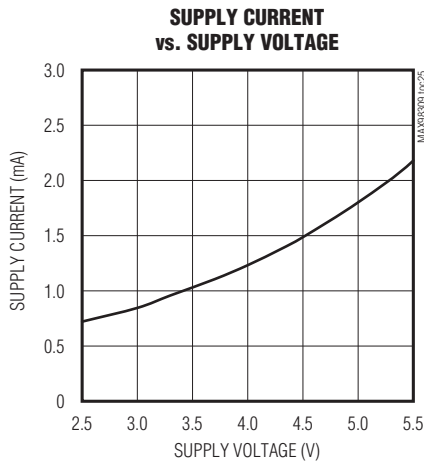
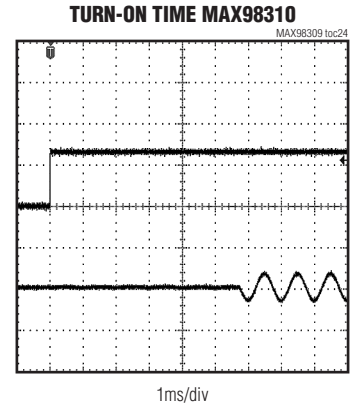
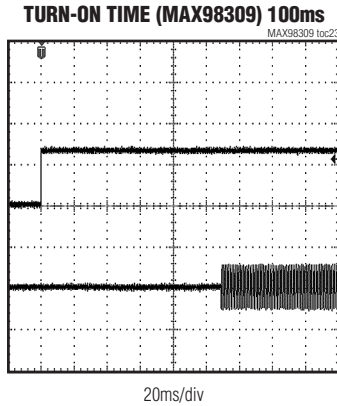
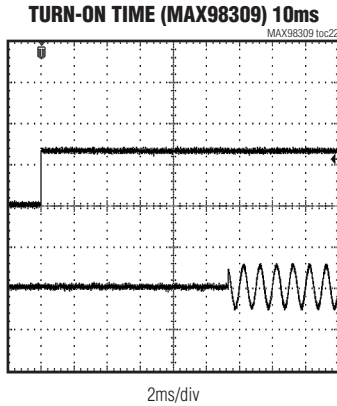

MAX98309/MAX98310

Mono 1.4W Class AB Audio Amplifiers

Pin Configurations

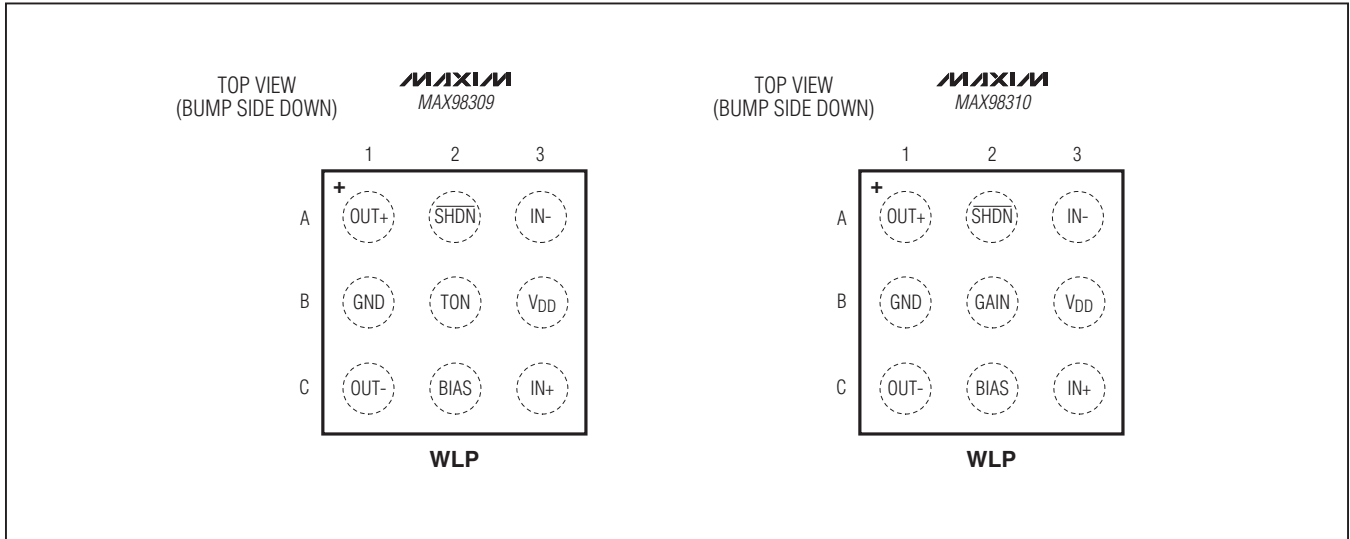

Pin Descriptions

| PIN | | NAME | FUNCTION |
|----------|----------|--------------------------|---|
| MAX98309 | MAX98310 | | |
| A1 | A1 | OUT+ | Amplifier Positive Output |
| A2 | A2 | $\overline{\text{SHDN}}$ | Active-Low Shutdown Input. Connect to GND to place the IC into shutdown. Connect to V_{DD} for normal operation. |
| A3 | A3 | IN- | Inverting Audio Input |
| B1 | B1 | GND | Ground |
| B2 | — | TON | Turn-On Time Selection. Connect TON to GND for a 10ms turn-on time. Connect TON to V_{DD} for a 100ms turn on time. |
| — | B2 | GAIN | Gain Select Input. See Table 1 for gain settings. |
| B3 | B3 | V_{DD} | Power Supply Input. Connect a 1 μ F capacitor from V_{DD} to GND. |
| C1 | C1 | OUT- | Amplifier Negative Output |
| C2 | C2 | BIAS | Common-Mode DC Bias Bypass. Connect a 0.1 μ F (min) capacitor to GND. |
| C3 | C3 | IN+ | Noninverting Audio Input |

MAX98309/MAX98310

Mono 1.4W Class AB Audio Amplifiers

Detailed Description

The MAX98309/MAX98310 mono 1.4W Class AB audio amplifiers offer low quiescent current while maintaining excellent SNR and low 0.008% THD+N. Both ICs feature excellent 90dB PSRR and state-of-the-art click-and-pop suppression.

The ICs are offered with an internally fixed 0dB, 3dB, 6dB, and 9dB gain (MAX98310) or an externally set gain (MAX98309) through external resistors.

The MAX98309 features a 10ms or 100ms pin-selectable turn-on time, while the MAX98310 has a preset 5ms turn-on time.

Bias

The ICs operate from a single 2.5V to 5.5V power supply and feature an internally generated common-mode bias voltage of $V_{DD}/2$ reference to ground. BIAS provides both click-and-pop suppression and sets the DC bias level for the audio outputs. Choose the value of the bypass capacitor as described in the [BIAS Capacitor](#) section. Do not connect external loads to BIAS as this can affect the overall performance.

Turn-On Time

The MAX98309 external gain amplifier features a selectable turn-on time for optimized click-and-pop performance. Connect TON to GND for a 10ms turn-on time. Connect TON to V_{DD} for a 100ms turn-on time. The MAX98310 has a preset 5ms turn-on time.

Shutdown Mode

The ICs feature a 1.8 μ A low-power shutdown mode that reduces quiescent current consumption. When the active-low shutdown mode is entered, the ICs' internal bias circuitry is disabled, the amplifier outputs go high impedance, and BIAS is driven to GND.

Click-and-Pop Suppression

The ICs feature Maxim's industry-leading click-and-pop suppression circuitry. During startup, the amplifier common-mode bias voltage ramps to the DC bias point. When entering shutdown, the amplifier outputs are high impedance between both outputs. This scheme minimizes the energy present in the audio band.

Applications Information

BTL Amplifier

The ICs are designed to drive a load differentially, a configuration referred to as bridge-tied load, or BTL. The BTL configuration ([Figure 1](#)) offers advantages over the single-ended configuration, where one side of the load is connected to ground. Driving the load differentially doubles the output voltage compared to a single-ended amplifier under similar conditions.

Substituting $2 \times V_{OUT(P-P)}$ for $V_{OUT(P-P)}$ into the following equations yields four times the output power due to doubling of the output voltage:

$$V_{RMS} = \frac{V_{OUT(P-P)}}{2\sqrt{2}}$$
$$P_{OUT} = \frac{V_{RMS}^2}{R_L}$$

Because the differential outputs are biased at midsupply, there is no net DC voltage across the load. This eliminates the need for DC-blocking capacitors required for single-ended amplifiers. These capacitors can be large, expensive, consume board space, and degrade low-frequency performance.

Power Dissipation and Heatsinking

Under normal operating conditions, the ICs dissipate a significant amount of power. The maximum power dissipation is given in the [Absolute Maximum Ratings](#) or can be calculated by the following equation:

$$P_{D(MAX)} = \frac{T_{J(MAX)} - T_A}{\theta_{JA}}$$

where $T_{J(MAX)}$ is +150°C, T_A is the ambient temperature, and θ_{JA} is the reciprocal of the derating factor in C/W as specified in the [Absolute Maximum Ratings](#).

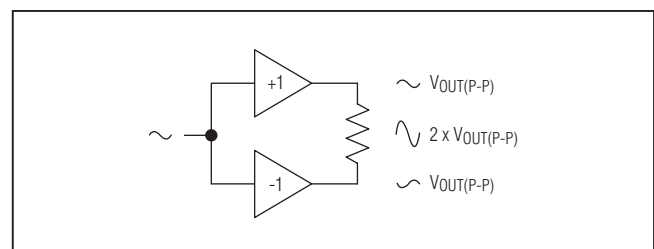

Figure 1. BTL Configuration

Mono 1.4W Class AB Audio Amplifiers

The increase in power delivered by the BTL configuration directly results in an increase in internal power dissipation over the single-ended configuration. The maximum internal power dissipation for a given V_{DD} and load is given by the following equation:

$$P_{D(MAX)} = \frac{2V_{DD}^2}{\pi^2 R_L}$$

If the internal power dissipation for a given application exceeds the maximum allowed for a given package, reduce power dissipation by increasing the ground plane heatsinking capability and the size of the traces to the device. See the [Layout and Grounding](#) section. Other methods for reducing power dissipation are to reduce V_{DD} , increase load impedance, decrease ambient temperature, reduce gain, or reduce input signal.

Thermal-overload protection limits total power dissipation in the MAX98309/MAX98310. When the junction temperature exceeds +160°C, the thermal protection circuitry disables the amplifier. Operation returns to normal once the die cools by 15°C.

Amplifier Gain

Fixed Differential Gain (MAX98310)

The MAX98310 features four internally fixed differential gain options selectable by GAIN ([Table 1](#)). This simplifies design, decreases required application footprint size, and eliminates external gain-setting resistors.

External Differential Gain (MAX98309)

The MAX98309 features an external gain option. Resistors R_F and R_{IN} . See the [Simplified Block Diagram](#) and set the gain of the amplifier as follows:

$$A_V = \frac{R_F}{R_{IN}}$$

where A_V is the desired voltage gain. Hence, an R_{IN} of 10k Ω and an R_F of 20k Ω yields a gain of 2V/V or 6dB. R_F can be either fixed or variable, allowing the use of a digitally controlled potentiometer to alter the gain under software control.

Table 1. Fixed Differential Gain

| GAIN CONNECTION | GAIN (dB) |
|-----------------|-----------|
| V_{DD} | 0 |
| GND | 3 |
| Unconnected | 6 |
| BIAS | 9 |

Input Filter

The fully differential amplifier inputs can be biased at voltages other than midsupply. The common-mode feedback circuit adjusts for input bias, ensuring the outputs are still biased at midsupply. Input capacitors are not required as long as the input voltage is within the specified common-mode range listed in the [Electrical Characteristics](#) table.

If input capacitors are used, input capacitor C_{IN} , in conjunction with the input resistor R_{IN} , forms a highpass filter that removes the DC bias from an incoming signal. The AC-coupling capacitor allows the amplifier to bias the signal to an optimum DC level. Assuming zero-source impedance, the -3dB point of the highpass filter is given by:

$$f_{-3dB} = \frac{1}{2\pi R_{IN} C_{IN}}$$

Setting f_{-3dB} too high affects the low-frequency response of the amplifier. Use capacitors with adequately low voltage coefficients, such as X7R ceramic capacitors with a high voltage rating. Capacitors with higher voltage coefficients result in increased distortion at low frequencies.

BIAS Capacitor

BIAS is the output of the internally generated $V_{DD}/2$ bias voltage. The BIAS bypass capacitor, C_{BIAS} , improves PSRR and THD+N by reducing power supply and other noise sources at the common-mode bias node, and also generates the clickless/popless startup DC bias waveform for the speaker amplifiers. Bypass BIAS with a 0.1 μ F capacitor to GND. Larger values of C_{BIAS} (up to 1 μ F) improve PSRR.

Supply Bypassing

Proper power-supply bypassing ensures low-noise, low-distortion performance. Connect a 1 μ F ceramic capacitor from V_{DD} to GND. Add additional bulk capacitance as required by the application. Locate the bypass capacitor as close as possible to the device.

Layout and Grounding

Good PCB layout is essential for optimizing performance. Use large traces for the power-supply inputs and amplifier outputs to minimize losses due to parasitic trace resistance and route heat away from the device. Good grounding improves audio performance, and prevents any digital switching noise from coupling into the audio signal.

MAX98309/MAX98310

Mono 1.4W Class AB Audio Amplifiers

Ordering Information

| PART | TEMP RANGE | GAIN | PIN-PACKAGE | TOP MARK |
|--------------|----------------|----------|-------------|----------|
| MAX98309EWL+ | -40°C to +85°C | External | 9 WLP | +AIY |
| MAX98310EWL+ | -40°C to +85°C | Fixed | 9 WLP | +AIZ |

+Denotes a lead(Pb)-free/RoHS-compliant package.

MAX98309/MAX98310

Mono 1.4W Class AB Audio Amplifiers

Package Information

For the latest package outline information and land patterns (footprints), go to www.maxim-ic.com/packages. Note that a "+", "#", or "-" in the package code indicates RoHS status only. Package drawings may show a different suffix character, but the drawing pertains to the package regardless of RoHS status.

| PACKAGE TYPE | PACKAGE CODE | OUTLINE NO. | LAND PATTERN NO. |
|---------------------|--------------|-------------------------|--|
| 9 WLP (0.3mm pitch) | W91D1+1 | 21-0486 | Refer to Application Note 1891 |

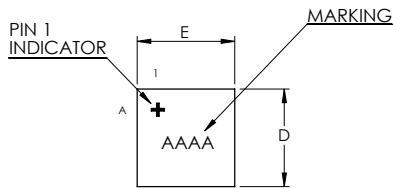

TOP VIEW

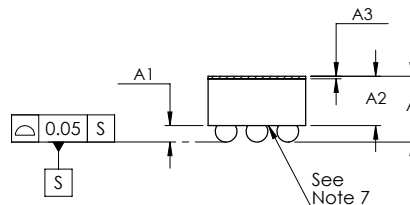

SIDE VIEW

| COMMON DIMENSIONS | |
|-------------------|-------------|
| A | 0.64 ±0.05 |
| A1 | 0.16 ±0.03 |
| A2 | 0.48 REF |
| A3 | 0.025 BASIC |
| b | 0.21 ±0.03 |
| D1 | 0.60 BASIC |
| E1 | 0.60 BASIC |
| e | 0.30 BASIC |
| SD | 0.00 BASIC |
| SE | 0.00 BASIC |

| PKG. CODE | E | | D | | DEPOPULATED BUMPS |
|-----------|------|------|------|------|-------------------|
| | MIN | MAX | MIN | MAX | |
| W91D1+1 | 0.95 | 0.98 | 0.95 | 0.98 | NONE |

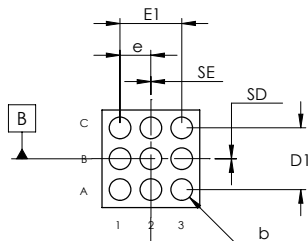

BOTTOM VIEW

NOTES:

1. Terminal pitch is defined by terminal center to center value.
2. Outer dimension is defined by center lines between scribe lines.
3. All dimensions in millimeter.
4. Marking shown is for package orientation reference only.
5. Tolerance is ± 0.02 unless specified otherwise.
6. All dimensions apply to PbFree (+) package codes only.
7. Front - side finish can be either Black or Clear.



| | | | |
|--|----------------------|------|-----|
| TITLE | | | |
| PACKAGE OUTLINE 9 BUMPS, WLP PKG. 0.3mm PITCH | | | |
| APPROVAL | DOCUMENT CONTROL NO. | REV. | 1/1 |
| | 21-0486 | B | |

-DRAWING NOT TO SCALE-

MAX98309/MAX98310

Mono 1.4W Class AB Audio Amplifiers

Revision History

| REVISION NUMBER | REVISION DATE | DESCRIPTION | PAGES CHANGED |
|-----------------|---------------|-----------------|---------------|
| 0 | 6/11 | Initial release | — |

Maxim cannot assume responsibility for use of any circuitry other than circuitry entirely embodied in a Maxim product. No circuit patent licenses are implied. Maxim reserves the right to change the circuitry and specifications without notice at any time. The parametric values (min and max limits) shown in the Electrical Characteristics table are guaranteed. Other parametric values quoted in this data sheet are provided for guidance.

Maxim Integrated Products, 120 San Gabriel Drive, Sunnyvale, CA 94086 408-737-7600 _____ 14