



BOARD LEVEL COOLING - 3741

3741 is a series of square pin fin board level heat sinks designed to cool BGA and FPGA devices. Representative image only.

ORDERING INFORMATION

Part Number	Device Type
374124B00035G	BGA, FPGA
374124B60023G	BGA, FPGA



HEAT SINK DETAILS

Property	Details
Material	Aluminum
Finish	Black Anodize
Device Attachment Options: 374124B00035G	Tape
Device Attachment Options: 374124B60023G	Solder Anchor Clip
Thermal Interface Material: 374124B00035G	T411 Chomerics Tape for All Surfaces
Thermal Interface Material: 374124B60023G	T766 Chomerics Phase Change for All Surfaces

Property	Details
Heat Sink Width (mm)	23.00
Heat Sink Length (mm)	23.00
Heat Sink Height (mm)	18.00
Heat Sink Mounting Direction	Horizontal, Vertical

MECHANICAL & PERFORMANCE

Drawing dimensions are shown in mm, (in)

Part Number: 374124B00035G

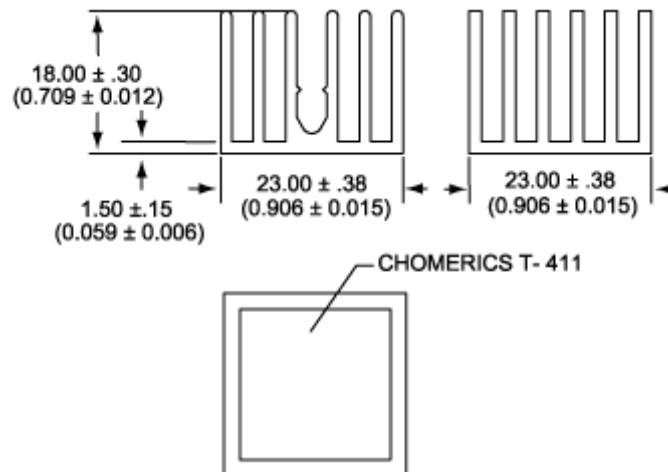

Part Number: 374124B60023G

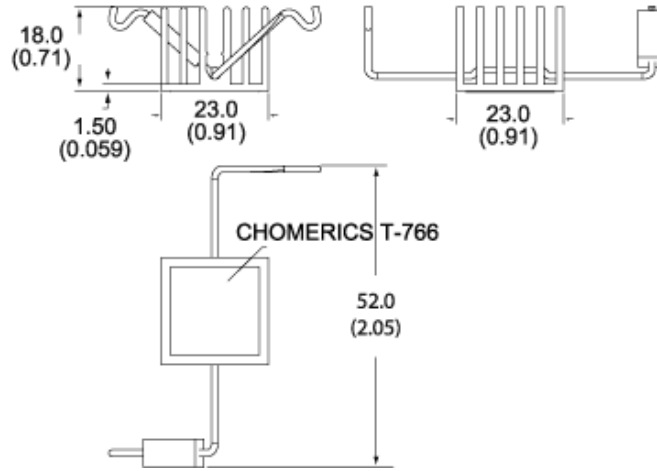

Mounting Details:

