

注記:
NOTES:

1. 材質: ポリエステル (PBT), UL94V-0, ナチュラル (白)
MATERIAL: POLYESTER (PBT), UL94V-0, NATURAL (WHITE)
2. 嵌合相手: 503471シリーズ
MATE WITH: 503471 SERIES
- △ 適合端子: 503485シリーズ
APPLICABLE TERMINAL: 503485 SERIES
4. ハーネス加工時及び輸送時においては、コネクタ間での絡みや衝撃、梱包時の積み重ねによる負荷がかからないように御注意願います。
WHEN TAKING A HARNESS CONNECTOR SHALL BE USED FREE FROM DIRECT EXCESSIVE FORCE AND TWISTED.
5. 本製品に黒点等が確認される場合や色合いが異なる場合がありますが、製品性能に影響はありません。
THERE IS NO INFLUENCE IN THE PRODUCT PERFORMANCE THOUGH THE BLACK SPOT ETC. MIGHT BE CONFIRMED TO THE PLASTIC PART OF THIS PRODUCT AND THE SHADE MIGHT BE DIFFERENT.
6. ELV及びRoHS適合品
ELV AND RoHS COMPLIANT.

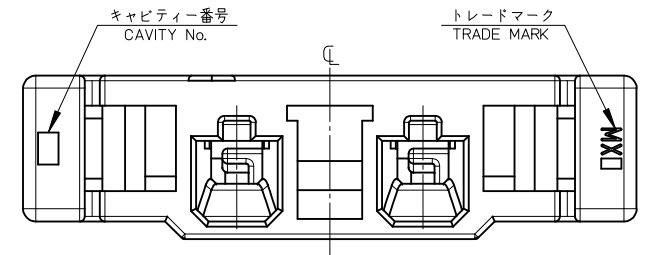
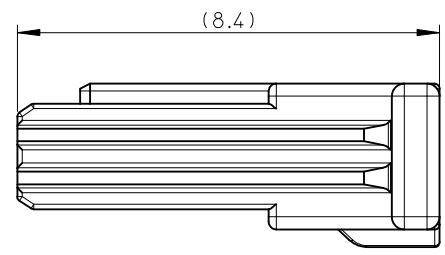
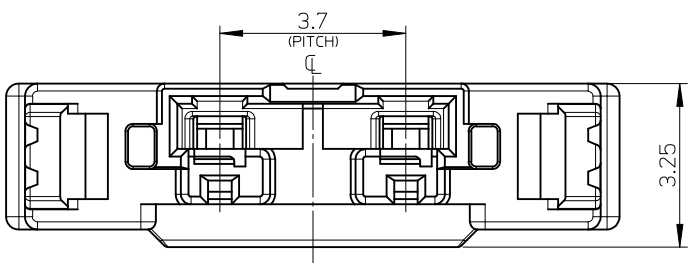
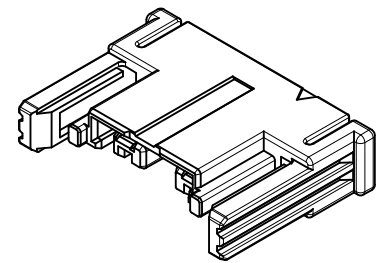

503473-0200	2
PLASTIC BAG	CIRCUIT 極数
オーダー番号 ORDER No.	
コネクタシリーズ番号 CONNECTOR SERIES No.	
503473-***00	

RELEASED EC No.: J2010-0155 DR: W.N.H.KOBAYASHI 2009/07/24 CH: K.D.SSAT003 2009/07/26 APPR: N.UKITA 2009/07/27	DESCRIPTION REV	GENERAL TOLERANCES (UNLESS SPECIFIED)		DIMENSION STYLE MM ONLY		SCALE 10:1	DESIGN UNITS METRIC	THIRD ANGLE PROJECTION	
		10 UNDER	±0.2	DRAWN BY H.KOBAYASHI	DATE 2009/7/24	TITLE 3.7 MULTIPLE CONN. PLUG CRIMP HS'G			
		10 OVER 30 UNDER	±0.25	CHECKED BY S.SATO	DATE 2009/7/24	MOLEX INCORPORATED DOCUMENT NO. SD-503473-001 SHEET NO. 1 OF 2			
		30 OVER	±0.3	APPROVED BY N.UKITA	DATE 2009/7/24				
		ANGULAR ±1 °		DRAFT WHERE APPLICABLE MUST REMAIN WITHIN DIMENSIONS		MATERIAL NO. —//—		THIS DRAWING CONTAINS INFORMATION THAT IS PROPRIETARY TO MOLEX INCORPORATED AND SHOULD NOT BE USED WITHOUT WRITTEN PERMISSION	
SIZE A3									

<嵌合状態図(参考)> 503473-****/503471-****
 <MATED CONNECTOR (REFERENCE)>
 (503473-****/503471-****)

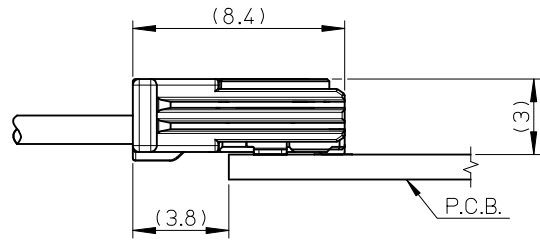
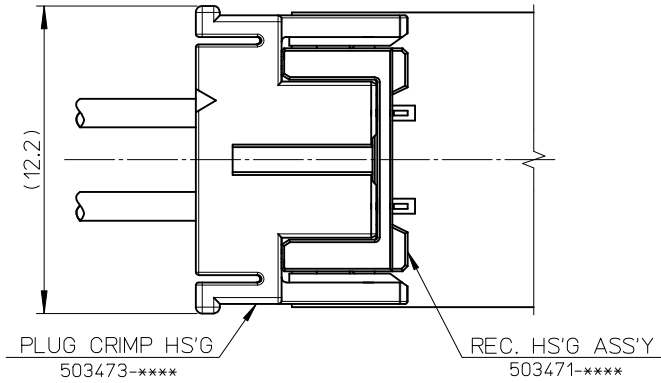

<端子挿入方向>
 <DIRECTION OF TERMINAL INSERTION>

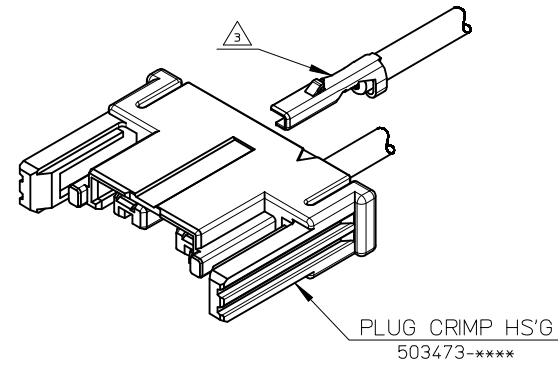

<端子装着状態図>
 <CRIMP TERMINAL ASSEMBLY>

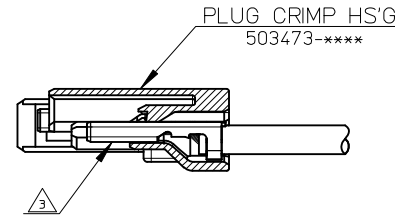

SEE SHEET No.1 EC NO.: J2010-0155 DRWN: H.KOBAYASHI 2009/07/24 CHKD: S.SATO 2009/07/26 APPR: N.UKITA 2009/07/27	GENERAL TOLERANCES (UNLESS SPECIFIED)		DIMENSION STYLE MM ONLY	SCALE 5:1	DESIGN UNITS METRIC	THIRD ANGLE PROJECTION	
	10 UNDER	±0.2	DRAWN BY H.KOBAYASHI	DATE 2009/7/24	TITLE 3.7 MULTIPLE CONN. PLUG CRIMP HS'G		
	10 OVER 30 UNDER	±0.25	CHECKED BY S.SATO	DATE 2009/7/24			
	30 OVER	±0.3	APPROVED BY N.UKITA	DATE 2009/7/24	MOLEX INCORPORATED DOCUMENT NO. SD-503473-001 SHEET NO. 2 OF 2		
	ANGULAR ±1 °		MATERIAL NO. —#—				
DRAFT WHERE APPLICABLE MUST REMAIN WITHIN DIMENSIONS		THIS DRAWING CONTAINS INFORMATION THAT IS PROPRIETARY TO MOLEX INCORPORATED AND SHOULD NOT BE USED WITHOUT WRITTEN PERMISSION					